

The Logic Systems Ci10 cabinet combines a 10" Mid/Bass cone with 1" compression driver on a 90 x 75 horn flare. The cabinet is part of the Ci series which is aimed specifically at the Bar and Club installation market. The Ci Series are available with a range of bracket options to aid installation and can also be ordered in special colours to fit the needs of the designers. Standard colours are black and white. The Ci Series aims to bring both an audio and build quality that is not common at this price point. To this end all Ci Series cabinets are constructed from birch ply and are rebated, glued and screwed.

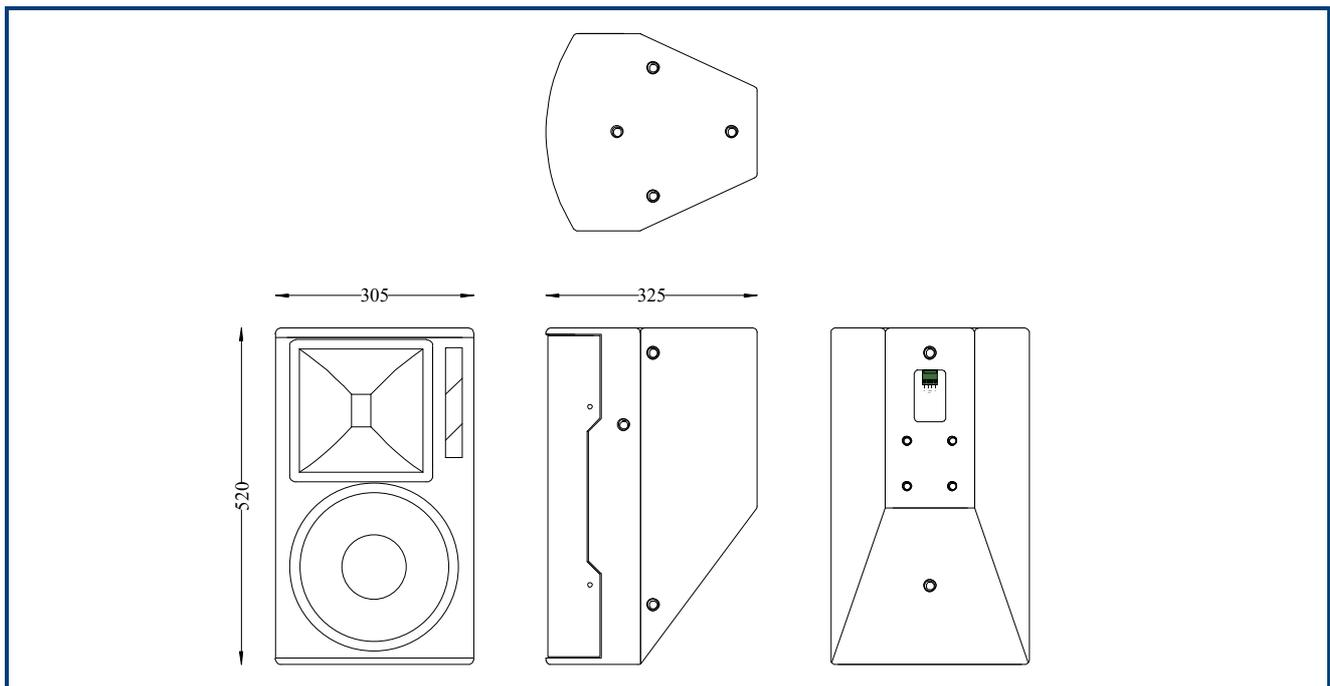

Frequency Response:	• 60Hz - 20kHz
Components:	• Bass/mid: 10" cone driver • HF: 1" exit compression driver, on CD flare
Power handling:	• 300w
Sensitivity (1):	• 97.5dB
Directivity:	• 90° x 75° above 1.5kHz
Impedance:	• 8 Ohms nominal
Construction:	• 15mm Birch plywood
Finish:	• Water based textured black paint
Connections:	• Phoenix screw terminal connector (supplied)
Dimensions:	• 305mm (W) x 520mm (H) x 325mm (D)
Packaged Dimensions (2):	• 780mm (W) x 680mm (H) x 420mm (D)
Weight:	• 18Kg

Cabinet	Handles	Tophat	M20	Castors	Bracket Pt.	Inserts/Fly Points
Ci10	No	No	No	No	Back	9 off M10 inserts

Note: (1) Sensitivity measured at 1 metre with 2.83V, using band limited pink noise.
(2) Please note that Ci10 cabinets are supplied boxed in pairs.